



Cover 1:
Cord Navy

Cover 2:
Rayleigh Midnight

Dark Wood Feet

Dexter Collection

Colours represented are to be used as a guide only.
Please refer to manufacturers swatch for a more accurate colour match.

Please note that colour shadings can vary slightly from each roll of fabric.
We cannot guarantee a precise match to these samples or between cut lengths and upholstered goods.

Extra Flex[®]
Soft, Supportive Seating

02/01/2024

DEXTER COVER GUIDE - STANDARD BACK

Please use this guide when ordering the following pieces to clarify cover options.

Corner Group: LH2, COR, RH1

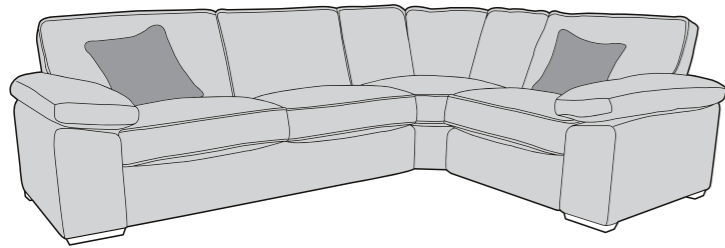

Corner Group: LH1, COR, RH2

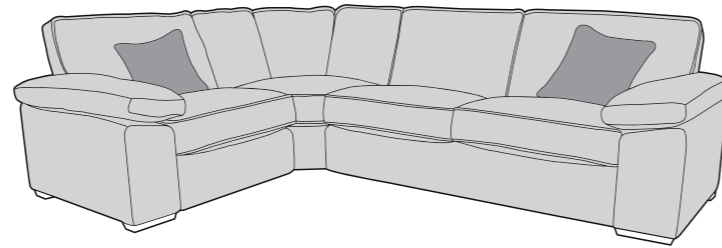

Corner Group: LH2, COR, RH2

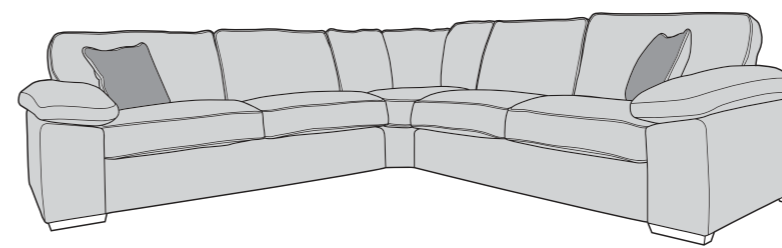

Corner Group: LH2, COR, R2V+VP

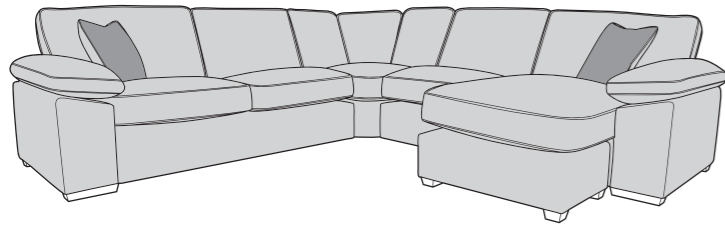

Corner Group: L2V+VP, COR, RH2

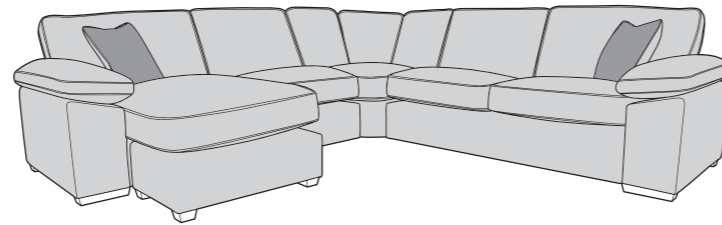

Corner Group: LH1, COR, RH1

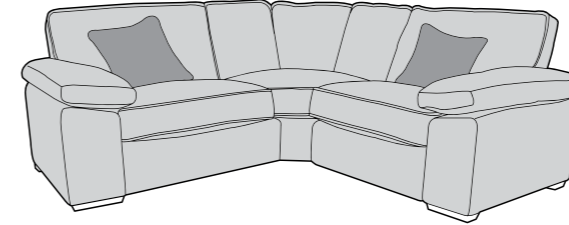

Chaise Sofa: 3RV, RFV

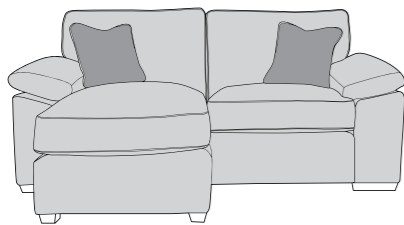

Armless Unit (ALU)

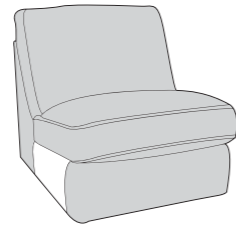

3 Seater Sofa (3ST)

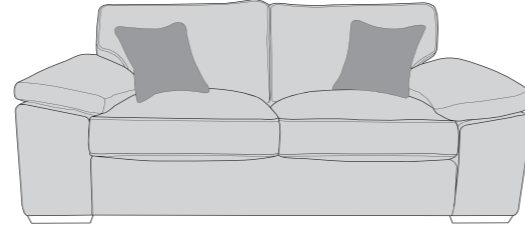

2 Seater Sofa (2ST)

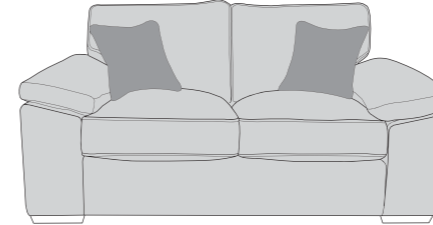

Love Chair (LOV)

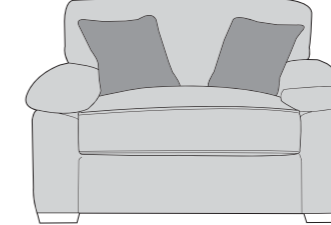

Arm Chair (1ST)

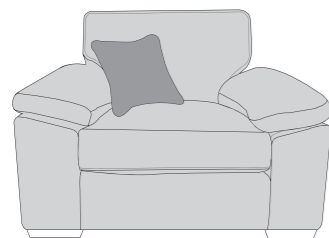

3 Seater Sofa Bed (3SB, 3DB)
(Available in Standard or Deluxe)

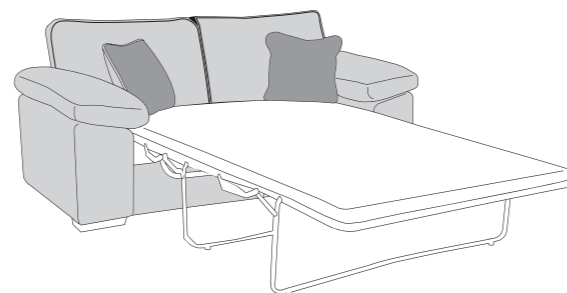

2 Seater Sofa Bed (2SB, 2DB)
(Available in Standard or Deluxe)

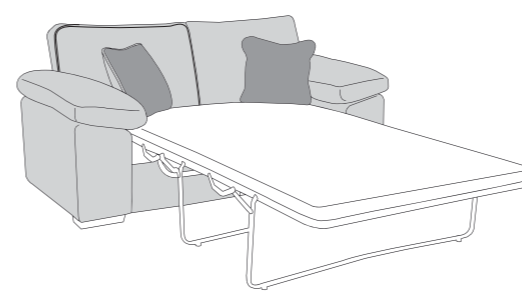

Chair Sofa Bed (1SB, 1DB)
(Available in Standard or Deluxe)

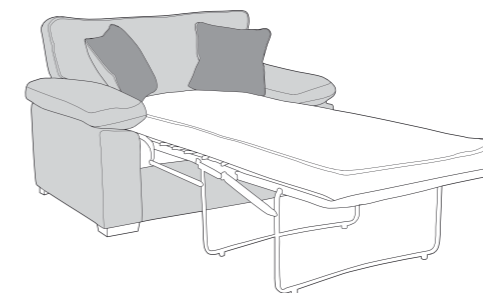

ACCENT PIECES

Storage Footstool (FSS)

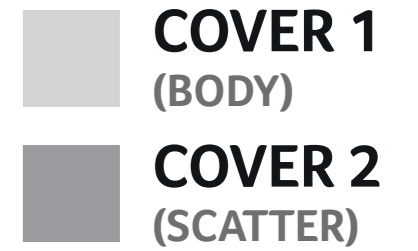
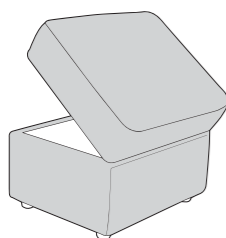

Scatter Cushions

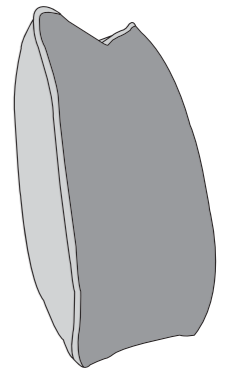

Front = Cover 2
Piping = Cover 1
Back = Cover 1



DEXTER DIMENSIONS (CM)

AVAILABLE PIECES	HEIGHT 1	WIDTH 2	DEPTH 3	SEAT HEIGHT 4	SEAT DEPTH 5	SEAT WIDTH 6	ACCESS DIAGONAL 7	OUTBACK HEIGHT 8	ARM HEIGHT 9	WEIGHT (KG)	SCATTER CUSHIONS
LH2, COR, RH2 GROUP	94	293	293	55	58	N/A	N/A	71	66	140.5	2
LH2, COR, RH1 GROUP or LH1, COR, RH2 GROUP	94	293	212	55	58	N/A	N/A	71	66	124.5	2
LH2, COR, R2V+VP GROUP or L2V+VP, COR, RH2 GROUP	94	293	293	55	58/109	N/A	N/A	71	66	148.5	2
LH1, COR, RH1 GROUP	94	212	212	55	58	N/A	N/A	71	66	108.5	2
CHAISE SOFA: 3RV, RFV	94	212	148	55	58/109	147	230	71	66	77	2
LH2/RH2 UNIT	94	189	97	55	58	151	208	71	66	53.5	1
LH1/RH1 UNIT	94	106	97	55	58	73	139	71	66	37.5	1
L2V+VP/R2V+VP UNIT	94	189	148	55	58/109	151	208	71	66	61.5	1
COR - CORNER UNIT	94	106	97	55	58	65	149	71	66	33.5	N/A
ALU - ARMLESS UNIT	94	80	97	55	58	80	122	71	66	21	N/A
3 SEATER SOFA (3ST)	94	212	97	55	58	147	230	71	66	62	2
2 SEATER SOFA (2ST)	94	184	97	55	58	115	203	71	66	58	2
LOVE CHAIR (LOV)	94	145	97	55	58	76	170	71	66	51	2
ARM CHAIR (1ST)	94	107	97	55	58	55	137	71	66	39.5	1
SOFA BEDS - STD BACK ONLY											
140CM STANDARD SOFA BED (3SB)	94	206	97	55	58	139	226	71	66	87	2
120CM STANDARD SOFA BED (2SB)	94	185	97	55	58	115	206	71	66	76	2
80CM STANDARD SOFA BED (1SB)	94	135	97	55	58	78	159	71	66	63	2
140CM DELUXE SOFA BED (3DB)	94	206	97	55	58	139	226	71	66	100	2
120CM DELUXE SOFA BED (2DB)	94	185	97	55	58	115	206	71	66	95.5	2
80CM DELUXE SOFA BED (1DB)	94	135	97	55	58	78	159	71	66	82.5	2
OPEN DEPTH OF SOFA BEDS 226CM											
ACCENT PIECES											
STORAGE FOOTSTOOL (FSS)	45	63	50	N/A	N/A	N/A	75	N/A	N/A	12.5	N/A

- * Hardwood & composite board frame.
- * Dowelled, screwed, glued & stapled joinery.
- * Light & Dark Wood foot options.

- * ExtraFlex high comfort seat cushions.
- * Fibre filled backs for added comfort.

- * Serpentine seat & silent wire.
- * Superloop back springs.

SOFA BEDS: 2 SLEEP OPTIONS

STANDARD ACTION & FOAM MATTRESS

A three fold metal action with a sprung 'polyprop' base. Complemented by a high performance foam mattress. For occasional use only.



Mattress Thickness: 6cm
Mattress Length: 185cm
3 fold action is 140Kg total max occupancy weight

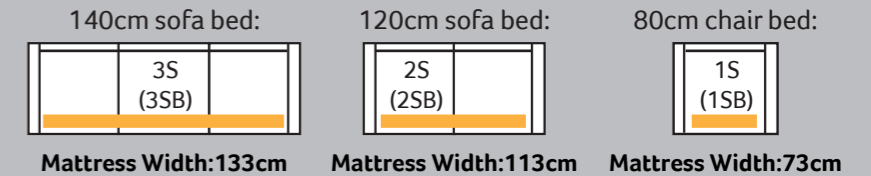

DELUXE ACTION & SPRUNG MATTRESS

A two fold metal action with beech slats. Complemented by a deluxe sprung mattress. For everyday use.



Mattress thickness: 11.5cm
Mattress Length: 183cm
2 fold action is 160Kg total max occupancy weight

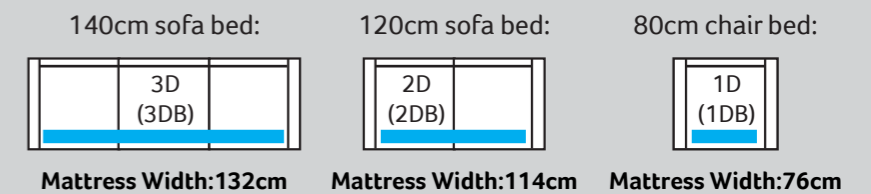

Sofa beds available as standard back only

DIMENSION GUIDE

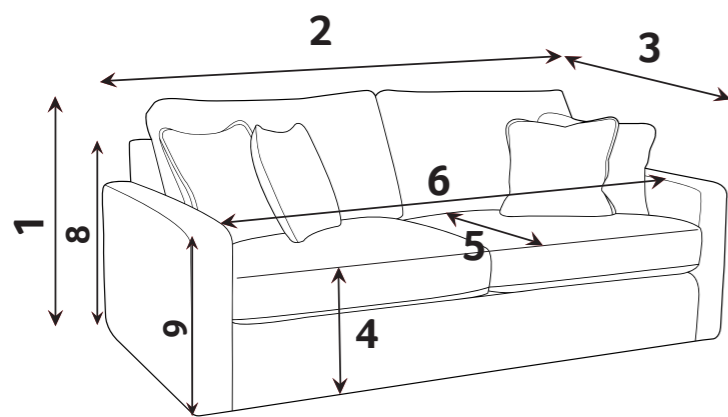

- 1 - HEIGHT
- 2 - WIDTH
- 3 - DEPTH
- 4 - SEAT HEIGHT
- 5 - SEAT DEPTH (STD & PILLOW)
- 6 - SEAT WIDTH
- 7 - DIAGONAL ACCESS
- 8 - OUTBACK HEIGHT
- 9 - ARM HEIGHT

Illustrations used for reference only.

Check the diagonal access dimension to ensure furniture will fit in your home.

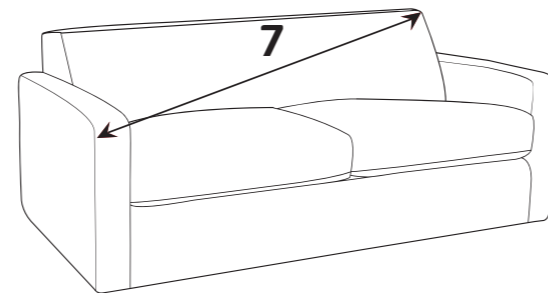

Extra Flex®

A high density foam base seat interior with a hand-rolled carded fibre, channelled topper which provides both softness and support.

CARE GUIDE

Extraflex seat cushions should be **plumped up on a regular basis** to help maintain the aesthetical appeal of your upholstery, the plumping of cushions is essential to help retain the comfort and softness of any piece of upholstered furniture.

To improve the longevity of your hand-made furniture, we recommend rotating cushions (where applicable).

For further information on maintaining your furniture please refer to the care guide located under the seat platform.

- FOOT OPTIONS:** Beech (Light) Mid Oak Brown (dark)

